

# Multilayer Press RMP 210 and RMP 3545

Translation of the original instructions



## Table of Content

<b>Preface.....</b>	<b>2</b>	<b>Work process.....</b>	<b>11</b>
<b>Technical Data.....</b>	<b>3</b>	<b>Composition of Press Stack.....</b>	<b>12</b>
<b>EG-Declaration of conformity.....</b>	<b>4</b>	<b>Cleaning and maintenance.....</b>	<b>14</b>
<b>Short instructions.....</b>	<b>5</b>	<b>Spare part list.....</b>	<b>14</b>
<b>Intended Use.....</b>	<b>6</b>	<b>Guarantee.....</b>	<b>15</b>
<b>Safety Regulations.....</b>	<b>6</b>	<b>Disclaimer of Warranty.....</b>	<b>15</b>
<b>Composition.....</b>	<b>7</b>	<b>Copyright.....</b>	<b>15</b>
<b>Setup.....</b>	<b>8</b>	<b>Pressing Preferences.....</b>	<b>16</b>

## Preface

### RMP 210 and RMP 3545 - Multilayerpresse

This high performance multilayer press was designed for PCB labs to enable quick prototyping of multilayer PCBs according to industry standards. The number of layers is only limited by the maximum lift of the press compartment.

A compact and floor standing aluminium rack contains all parts of the unit including pressure supply, press plates and heaters. The large loading door that allows quick and easy access to the pressure part is of course security switch protected.

A compressor, which is integral part of RMP series is stored in the back of the machine. In the front, you will find additional storage room for tools or boards (lower door). the unit is controlled by two digital and adjustable thermostats, one digital timer as well as a pressure valve with pressure meter. Two strong air ventilators activated automatically during cooling cycle.

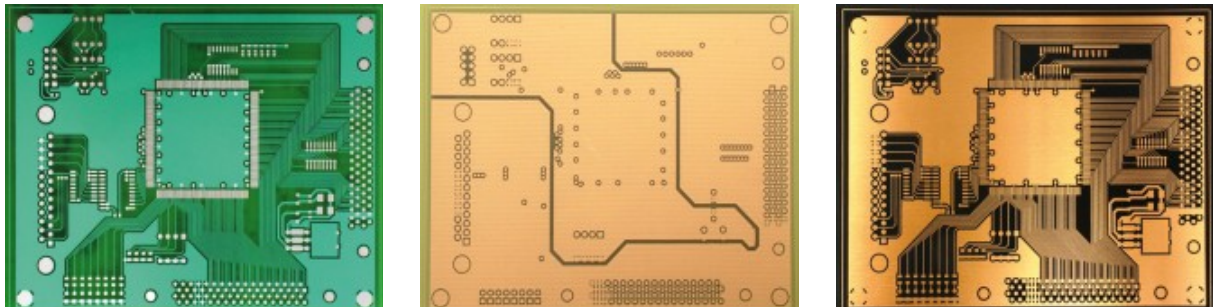

Steps of multilayer production with RMP 210 / RMP 3545:

- 
- boards are pinned and stack is inserted into press plates
- pressure is created
- heater is activated
- heating up procedure
- press procedure at preset temperature
- cooling down under pressure
- PCB stack is taken out of the machine



The entire sequence will take approx. 3 hours if you start at 20°C and take out the pcbs at a temperature of 30°C. If you take up protective measures, you can remove the boards at higher temperatures and insert a new stack. This way the press cycle reduces to approx. 45min. Gross size of the PCBs is 250 x 350 mm (RMP 3545: 350x450mm) which corresponds to a PCB net size of 210 x300 mm (RMP 3545: 300x400mm).

The space between the heating plates is 40 mm. If you use our standard press plates and separate the 1.5 mm thick multi-layers with 1.5 mm press sheets you can make about 7 multilayers simultaneously.

Since the pressing force is generated pneumatically, it ensures that the pressure is distributed evenly over the surface.

To register the layers of your multilayer you can use the register hole function of our software IsoCam and the Bungard Favorit fixes the layers with rivets.

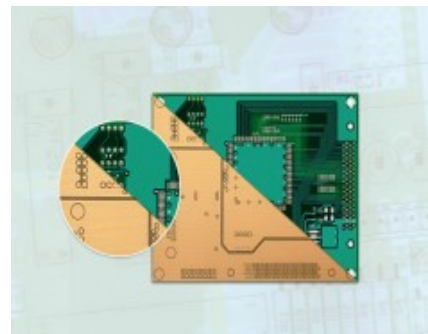
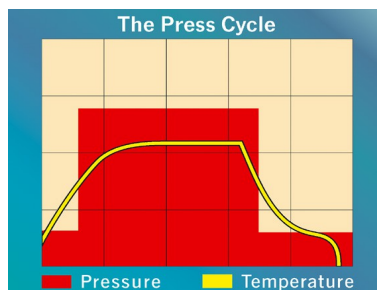
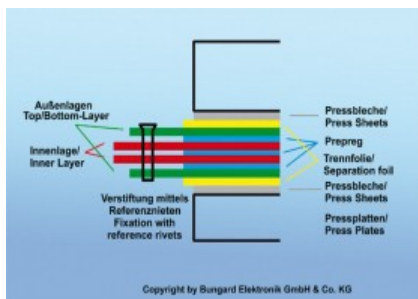

**Technical Data**

	<b>RMP210</b>	<b>RMP3545</b>
<b>Board size:</b>	gross 250 x 350 mm net approx. 210 x 300 mm	gross 450 x 350 mm net approx.. 400 x 300 mm
<b>Pressure:</b>	> 12 t	> 24 t; max. ca. 30t
<b>Compressor:</b>	0-15 bar included in delivery	0-15 bar included in delivery
<b>Temperature:</b>	250 °C	250 °C
Heating up:	ca 30 min.	ca 30 min.
<b>Pressing Time:</b>	ca. 60 min.	ca. 60 min.
<b>Cooling down:</b>	ca 120 min.	ca 120 min.
<b>Dimension:</b>	ca 650 x 650 x 1300 mm	ca. 830 x 820 x 1600 mm
<b>Space requirements:</b>	700 x 1500 mm <sup>2</sup>	870 x 1500
<b>Weight:</b>	ca. 130 kg	ca. 350 kg
<b>Electrical connection:</b>	230 V 50 Hz 16 A	400V 50Hz 5000W 16 A Fuse per phase
<b>Maximum press stack:</b>	Distance between heating plates: 42-43 mm, Press plates 2x10mm → ca. 22mm Press stack height	Distance between heating plates: 38-40 mm, Press plates 2x10mm → ca. 18mm Press stack height

Technical changes possible and reserved at any times.

## EG-Declaration of conformity



### EG-Konformitätserklärung/Declaration of Conformity

Hersteller / Supplier:	Bungard Elektronik GmbH & Co. KG Rilkestraße 1 51570 Windeck Germany
Bevollmächtigte Person für die Zusammenstellung der technischen Unterlagen: Person in charge	Jürgen Bungard, Geschäftsführer /general director Rilkestraße 1 51570 Windeck Germany
Produkt:	Multilayer press RMP 210 und RMP3545

Hiermit erklären wir, dass die oben beschriebenen Maschinen allen einschlägigen Bestimmungen der Maschinenrichtlinie 2006/42/EG entspricht.

Die oben genannte Maschine erfüllt die Anforderungen der nachfolgend genannten Richtlinien und Normen:

We hereby declare that the machines described above complies with all relevant provisions of the Machinery Directive 2006/42/EC.

The above machine meets the requirements of the following guidelines and standards:

- **Maschinenrichtlinie 2006/42/EG / Machinery Directive 2006/42/EC**
- **EMV-Richtlinie 2014/30/EG / EMC Directive 2014/10830EC**
- **Niederspannungsrichtlinie 2014/35/EG / Low Voltage Directive 2014/35/EC**
- **DIN EN 60204-1** Sicherheit von Maschinen - Elektrische Ausrüstung von Maschinen - Teil 1: Allgemeine Anforderungen / Safety of machinery - Electrical equipment of machines - Part 1: General requirements
- **DIN EN ISO 14121-1** Sicherheit von Maschinen - Risikobeurteilung - Teil 1: Leitsätze / Safety of machinery - Risk assessment - Part 1: Principles
- **DIN EN ISO 12100-1** Sicherheit von Maschinen - Allgemeine Gestaltungsleitsätze, Risikobeurteilung und Risikominderung / Safety of machinery - Basic concepts, risk assessment and risk reduction
- **DIN EN 55014-1 2012-05** Elektromagnetische Verträglichkeit, Anforderungen an Haushaltsgeräte, Elektrowerkzeuge und ähnliche Elektrogeräte, Teil 1: Störaussendung / Electromagnetic compatibility Requirements for household appliances, electric tools and similar electrical appliances Part 1: Emission
- **DIN EN 55014-2-2009-06** Elektromagnetische Verträglichkeit - Anforderungen an Haushaltgeräte, Elektrowerkzeuge und ähnliche Geräte - Teil 2: Störfestigkeit - / Electromagnetic compatibility - Requirements for household appliances, electric tools and similar apparatus - Part 2: Immunity
- **Niederspannungsrichtlinie / Low Voltage Directive 2014/35/EG**
- **Maschinenrichtlinie / Machinery Directive 2006/42/EG/37/EG**

Windeck, 10.1.2018

\_\_\_\_\_  
Jürgen Bungard Geschäftsführer

## Short instructions

### Commissioning:

Remove the packaging and inspect the machine for transport damage.

Read the instructions thoroughly and observe all safety instructions.

Lift the machine off the pallet using a forklift. Afterwards the RMP can be rolled to your place of installation.

RMP3545: Have your plant electrician connect the RMP3545 to 400V, 3-phase, 50Hz.

### Operating:

Place the press plates in the press chamber for a functional test.

Switch on the power switch (**MAINS** also serves as emergency stop, right in the control panel). The compressor starts.

Switch on the pressure by pressing **PRESSURE** (compressor might restart).

On the hand wheel at the bottom left, set the desired pressing pressure. This depends on the material type, age of the prepregs and most important: the size of your press pack. For an overview, see **Printing Preferences**. For material from the RMP starter set with a press package size of 250 x 350mm (RMP210) set as standard 12 bar (for the RMP3545 and press package size 350x450 is 8 bar).

Set the desired pressing time at the timer. After pressing **PROG**, the hour digits flash. With **+** or **-** you can change the value. If you press **PROG** again, the minutes digits flash, then the seconds digits flash. After the 4th press of **PROG** the normal display reappears and you can start the press cycle by pressing - (**Start / Stop**). For material from the RMP Starter Set, the default time is 90 minutes (1:30:00).

Only after the pressing cycle is started, the temperature controls light up. The green display value corresponds to the current heating-up specification (TARGET TEMPERATURE). The upper, red value represents the currently reached temperature (CURRENT TEMPERATURE). To change the preset temperature: Press **MODE** and then the **arrow keys** to set the desired heating temperature, for example to 155 ° C as shown in this figure. Then press the button (**MODE**) again to save the selected value. Heating starts with a pre-set ramp of 6 ° C / minute. After the set time has elapsed, the heating will switch off and the fans will automatically switch off to cool down.

If you set higher temperatures than 175 ° C, you have to switch on the additional fans manually at the beginning of the pressing cycle, so that the environment of the heating plates does not overheat. Let the press stack cool sufficiently before removing it or wear appropriate protective gloves.

Let the press stack cool sufficiently before removing it or wear appropriate protective gloves.

Let the press stack cool sufficiently before removing it or wear appropriate protective gloves.

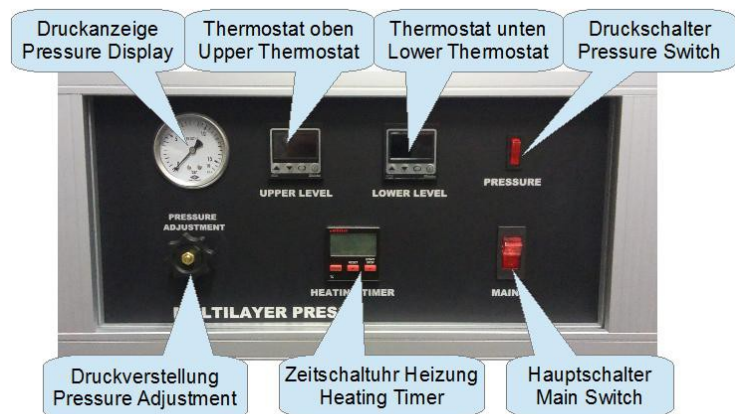



## Intended Use

The multilayer presses RMP 210 and RMP 3545 are used for the production of multilayers in an industrial-type equivalent frame.

All other applications require our written consent or at the user's own risk.

## Safety Regulations

### General

Please read the following text carefully and pay particular attention to the instructions on work safety and on commissioning.

Please keep these instructions carefully. It contains instructions that are also important for later maintenance or cleaning work.

The machines are not intended for integration or interconnection with other machines or equipment. They may only be operated in rooms equipped for this purpose and only operated by qualified specialist staff. Children and pets are to be kept away!

### Transport

Only use suitable lifting and transport equipment such as forklift trucks or pallet trucks. Secure the machine against slipping / tilting. Attention, high center of gravity!

Transport machine only vertical! Do not carry horizontal by any means!

### Installation site

The machine must stand level and there must be sufficient space for operation and maintenance.

The installation environment is critical to the trouble-free work with the RMP. You must therefore pay special heed on a dust-free room and an atmosphere free of corrosive vapours to ensure proper functioning.

### Electrical connection

The machine is manufactured using tested parts in accordance with the usual electrical safety regulations. However, this does not relieve the user of his duty of care when handling electrically operated devices.

The red main switch disconnects the machine from the power supply. We assume a proper building installation including ground earth, current breaker (RCCB) and suitable fuses.

After completing the work, always turn off the main switch.

Before carrying out any work on the machine (cleaning, etc.), switch off the machine and pull out the mains plug.

### Work safety

The machine is equipped with a door safety switch. When the door is opened, the compressed air for the press is deactivated.

This can destroy your multilayer circuit, but it is an important security feature of this machine.

Please check the function of the position switch regularly.

Machine may only be used with press plates in the press unit.

### Personal protective equipment

When handling hot parts wear protective gloves. The safety instructions of the manufacturer or the safety instructions of the supplier must be observed.

### Temperature

If the machine is heated higher than 175 ° C, a cooling fan (on the back of the machine) must be manually switched on to cool the periphery.

Pay attention to suitable materials to avoid fire and related financial losses.

Continue to ensure suitable pressing temperatures to prevent burning of the printed circuit board material and thus the possible formation of toxic and hazardous gases.

Allow the machine to cool down to a maximum of 50 ° C (approx. 30 - 45min) to avoid severe skin burns when removing it, or wear suitable gloves.

At temperatures above 200 ° C, purely optical colour changes of the press plates may occur. These do not represent any technical defects.

### Exhaust

Extracting the room air in the area above the machine body is recommended with regards to possible PCB gas emissions. The need for extraction depends on the materials used and the temperatures set.

### Pressure

Before the compressor starts after switching on the machine, remove all parts from the press plates, which could damage the machine or cause it to burst and can be propelled out of the machine.

Machine must not be operated without the two 10 mm press plates!

Compressor

WHILE THE COMPRESSOR IS RUNNING, DO NOT OPEN THE MACHINE OR OPEN THE DOOR TO THE PRESS ROOM.

## Composition

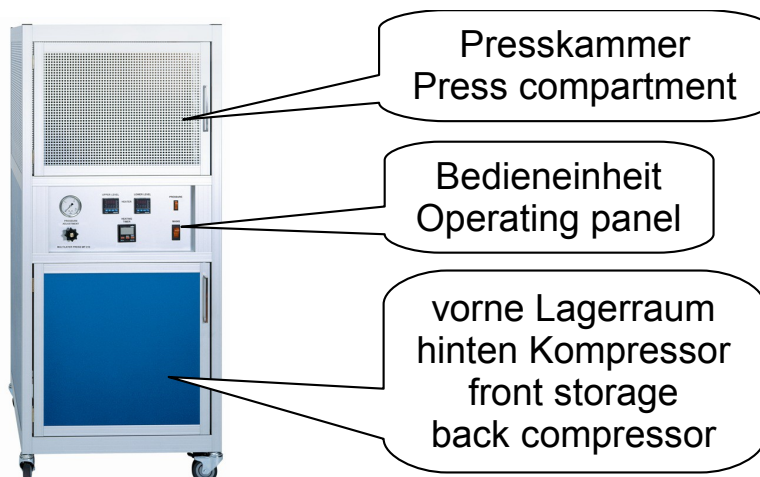

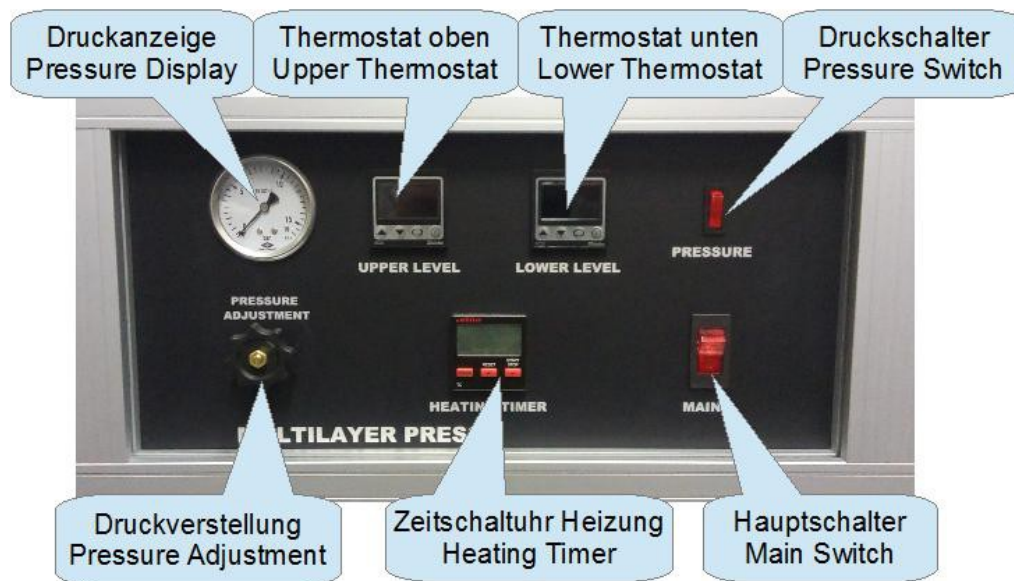

## Setup

The machine is delivered in a special wooden packaging. Please first check the condition of the packaging upon receipt of the goods. Only acknowledge receipt of the goods by the forwarder as okay if the packaging is in perfect condition. Otherwise this will endanger any claims to the transport insurance.

If you notice damage only when unpacking the machine, please report them as concealed damage also immediately in written form to the forwarder, your transport insurance and also to us.

To unpack the machine, first remove the side and top boards. The machine will then stand in front of you on a pallet.

Only use suitable lifting and transport equipment such as forklift trucks or pallet trucks. Secure the machine against slipping / tilting. Attention, high center of gravity!

Transport machine only vertical! Do not carry horizontal by any means!

The machine must stand level and there should be sufficient space for operation and maintenance.

Lock the rollers before first use.

Clean the machine of any transport contamination.

Connect the machine to the electrical supply indicated on the machine plate. If necessary, consult a qualified electrician (RMP3545).

Perform a test run. Make sure that the two press plates are correctly in the press chamber.

The main switch on the right side of the front plate also serves as an emergency stop switch.

Turn on the device above. The compressor will start now.

The machine is equipped with a special compressor located in the rear body of the machine. You can reach it by unscrewing the rear wall of the device (under the device Mains plug).

**ATTENTION: OPEN THE MACHINE'S BACK ONLY AFTER YOU HAVE PULLED THE POWER PLUG. DANGER!**

Before starting the compressor, remove all parts from the press plates, which could damage the machine or burst and be thrown out of the machine.



### Pressure setting

As soon as you press the "PRESSURE" button, the RMP drives the press plates together. Since this requires compressed air, the compressor will start again for about 2-3 minutes.

**DANGER:**

**WHILE THE COMPRESSOR IS RUNNING, DO NOT OPEN THE MACHINE OR OPEN THE DOOR TO THE PRESS ROOM.**

The pressure is adjusted via the hand wheel on the front of the device.

For the correct pressure setting, please observe the processing instructions of the board material manufacturer. As a guideline, please set a pressure of 12 tons / m<sup>2</sup> = 12 bar for a plate of 250x350mm<sup>2</sup>.

Details about the pressure setting can be found in the appendix.

### Timer

The timer controls the heating and cooling sequence of the RMP 210.

The set time resembles the complete heating time including the heating up sequence (you can calculate the approximate heating up time with the difference between set temperature minus current temperature divided by 6 ° C / min. After the set total time has elapsed, the heater is switched off and the cooling phase is started when the cooling fans are switched on. To reset the timer, please press all 3 buttons for about 4 seconds.

### Safety rules timer

Installation and connection may only be carried out by a qualified electrician! Otherwise there is a risk of fire or electric shock!

Only connect a voltage and frequency indicated on the rating plate / timer!

Interventions or changes to the timer will void the warranty!

The timer must be installed in such a way that unusually strong interfering radiation may not affect the function!



### Key functions

[ PROG ]	Selects between hours, minutes and seconds.
[ + ]	Increments the selected time range.
[ - ]	Decrements the selected time range.
[ RESET ]	Resets to start time.
[ START/STOP ]	Starts and stops the countdown.

### Setting the time

- Press the [ PROG ] button once.
- This will cause the hour digit to flash.
- Using the [+] [-] keys to set the desired amount of hours required.
- Repeat the process to set minutes and seconds.
- When keeping keys [+] or [-] depressed, the flashing digit will change upwards or downwards.
- Please note:** After starting the countdown, the key [PROG] is without function until counting is finished.

### Operating the timer

Pressing the [START/STOP] button activates the relay and the set time begins to count down in one second steps.

If the [START/STOP] button is pressed during the countdown period, the relay will de-energize and time remaining is shown on the display.

The timer can also be started and stopped from the external connections.

When the set time reaches zero the unit emits an audible signal, the relay de-energizes and the set time is indicated on the display.

**Please note:** If the [START/STOP] button is pressed and the time is zero, a bell symbol is shown on the display and the relay will energize. Pressing the button again will de-energize the relay.

### Resetting to the time

Pressing the [RESET] button will set the time back to the start time.

### Time reset

Pressing all three buttons together will set time to zero.

### Total Reset

Press and hold down all three buttons for approx four seconds.

### Data Storage on Loss of Power

**On loss of power the countdown will stop and the relay de-energize. The time remaining will be stored.**

When power is resumed the remaining time will be shown and the timer will need to be restarted.

### Setting the heater

The upper and lower heating levels can be programmed separately.

Both thermostats are set to a maximum operating temperature of 250 ° C.

The heating rate is programmed at the factory with 6°C/min, but is in principle adjustable to other values. Please contact us for the original instructions for the thermostats.

The green display value corresponds to the current heating-up specification (TARGET).

The upper, red value of the respectively reached heating temperature (CURRENT).

Adjustment of the default temperature:

Press the button (MODE) and then the arrow keys to set the desired heating temperature, for example to 175°C as shown in this figure.

Then press the button (MODE) again to save the selected value. The heating up can start now.

The thermostat has a "soft" heating control, which should avoid "overshooting" the set temperature.

For this reason, the temperature is ramped up gradually to the set default value.

The LED (OUT) indicates whether the heater is on or off.

The temperature to be set depends on the specifications of the material manufacturer and on the gelling temperatures of the prepregs, as well as on the age of the prepregs.

**ATTENTION:** If the set temperature is too low or the process time too short, this can lead to rejects and delamination. Both destroy the multilayer circuit.



## Work process

The workflow described here is a process pattern. It can and must be adapted to the specification of the prepreg manufacturer and to the layer specification.

- If you do not use floating press technology (only possible with 4-layer multilayers), it is best to pin-lock the plates outside the press area to align the layers correctly. To do this, drill all layers and also use these holes as registration marks in the film. We recommend cutting the prepregs smaller than the registration mark spaces to prevent resin from flowing into the registration marks holes.
- Place your press stack between the press plates.
- Protect the press plates from sticking by kraft paper or Tedlar foil (release foil). Pay attention to suitable materials to avoid a fire and thus substantial financial losses.
- Continue to ensure suitable pressing temperatures in order to avoid burning of the printed circuit board material and thus the possible formation of toxic and hazardous gases.
- Set the pressing pressure for a plate from 210x300mm<sup>2</sup> to 12 bar (RMP3545 for plate 330 x 420mm<sup>2</sup> to approx. 8 bar).
- For normal FR4 prepregs set a temperature of 155 - 175 ° C.
- activate the heater.

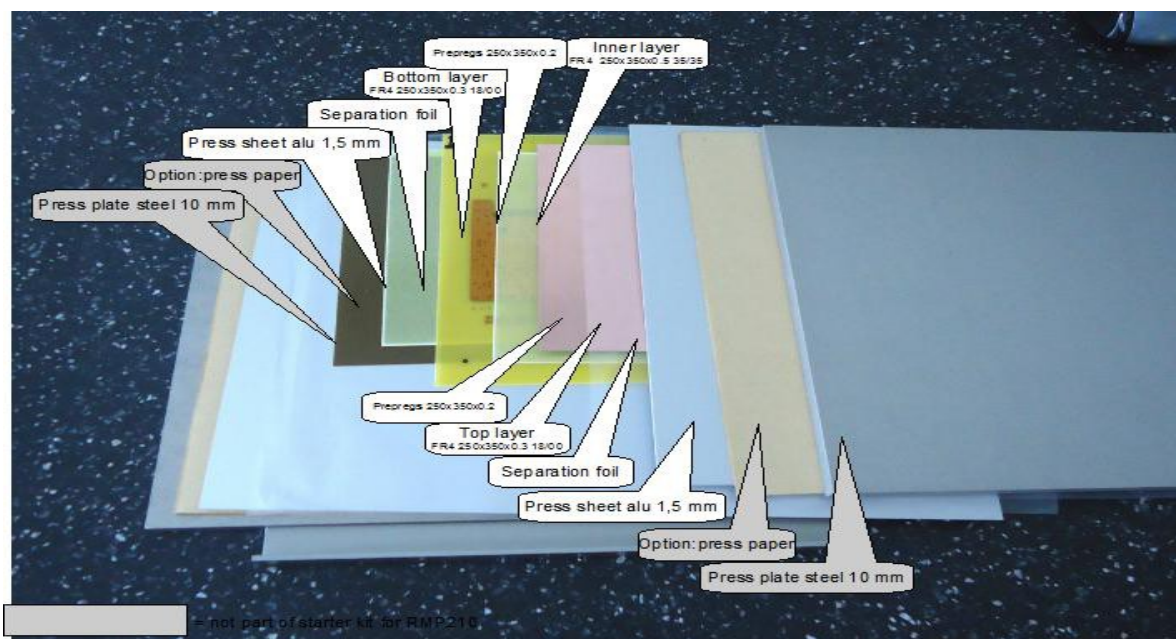

- a normal press cycle with FR4 depending on start and take-out temperature between 1 and 2 hours (according to type of pre-press and age of the prepregs).
- Allow the machine to cool to a maximum of 50 ° C (approximately 30-45 minutes) to avoid severe skin burns when removing, or use suitable gloves.
- In no case should the plate material be removed at more than 100 ° C. The resin will still be in Gel -condition and the stack could delaminate.
- Take the final stack out of the machine and remove the pinning.

The whole process takes up to 3 hours. The raw format of the plates generally changes from 250x350 mm to 210x300mm<sup>2</sup> (due to the flow behavior of the resin / keyword: poor resin).

If you take appropriate measures to ensure that the plate stack comes out of the oven at a temperature of 100 ° C, you can reduce the process times to half an hour. This adjustment is solely the responsibility of the supervisor and we disclaim all liability.

## Composition of Press Stack

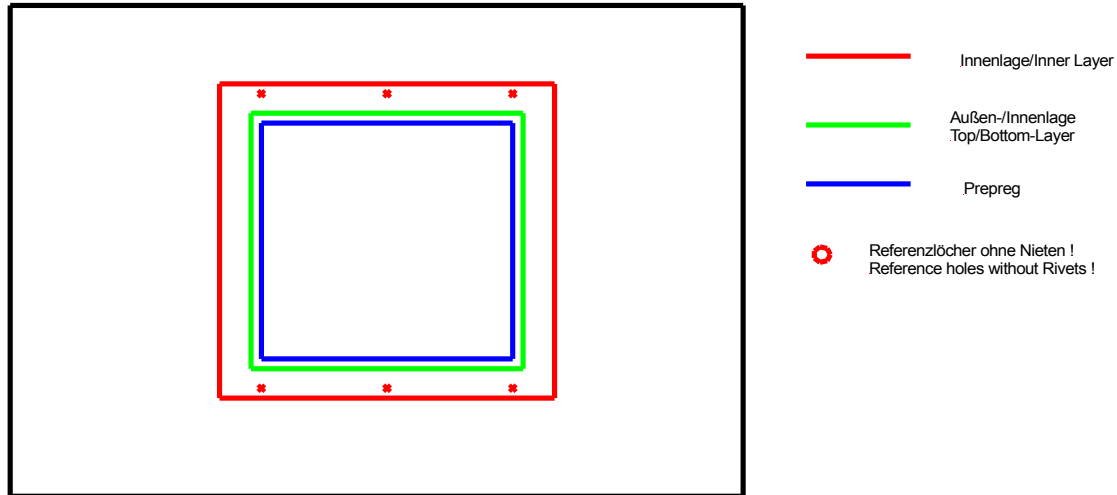

Copyright by Bungard Elektronik GmbH & Co. KG

You can press up to 4 Layers in floating technique. Add reference holes into your inner layers and adjust your layouts according to these holes.

Reference holes can be inserted into your layout with the help of IsoCam and can be drilled with the Bungard CCD.

Cut your prepregs and your outer layers smaller (as seen in the upper picture), so the resin of the boards will not flow into the reference holes during the press cycle. You will need these reference holes later on to register your pcb again for drilling on the CCD.

If your pcb is smaller than the press area of the machine (250 x 350 mm), we recommend to adapt the pressure according to this formula:

$$P_A = (P_W \times A_W) / A_A$$

$P_A$  = desired pressure for your pcb in bar

$P_W$  = machine pressure RMP 210) in bar

$A_W$  = press area of machine (250 x 350 mm = 8.75 dm<sup>2</sup> = constant)

$A_A$  = press area of your pcb in dm<sup>2</sup>

Example:

If you want to press a pcb with 120 x 120 mm with a pressure of 16 bar, please adjust formula:

$$(P_A \times A_A) / A_W = P_W$$

$$(16 \text{ bar} \times 1,44 \text{ dm}^2) / 8,75 \text{ dm}^2 = 2,63 \text{ bar}$$

Set this pressure at the machine. For small pcbs we generally recommend to panelize the pcb and so increase the press area.

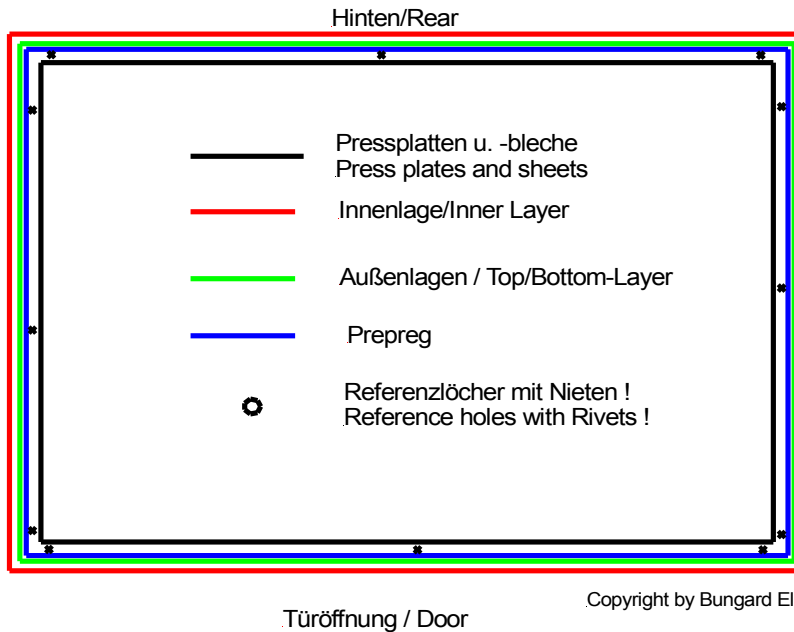

If you want to press more than 4 layers, it is necessary to fix all layers with reference pins to prevent the layers from moving during the press cycle.

Again you can add reference holes into your pcb with IsoCam and drill them with the Bungard CCD.

Reference rivets D3.0 x 5.4 mm can be obtained from Bungard in packages of 100 rivets.

These rivets have to be mounted outside of the press area as in the upper picture, so they can be easily removed after pressing.

See picture 3 for a sectional view on a press stack. The press sheets protect the press plates from mechanical damage and the separation foil protects both press sheet and press plate from contamination with resin

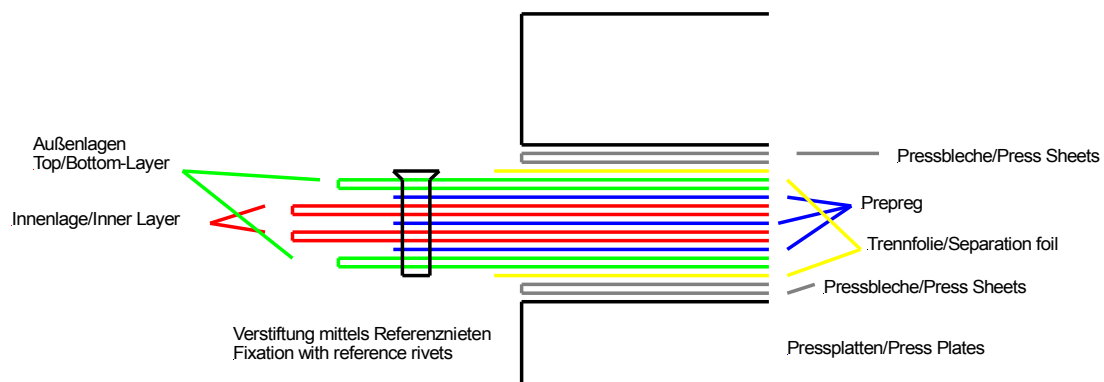



Copyright by Bungard Elektronik GmbH & Co. KG



### Cleaning and maintenance

The machine itself is maintenance free. When pressing, make sure that any escaping resin is caught by the Teflon films. Press plates can be cleaned with brushing machines and special solvents.

### Spare part list

80173		Startpaket Multilayerpresse RMP 210, 100	consumables starter kit for Multilayer Press RMP	
80173-2		Trennbleche 250x350 mm	Metal separator sheets 250x350mm	
80173-3		TEDLAR Entformungsfolie 250x350mm	TEDLAR separation foil 250x350mm	
6000	K2983.01-230	Magnetentlastungsventil	Solenoid valve	
6000	A 1362	Druckregler 1/4" 0 - 16 bar	Pressure reducer 1/4" 0-16 bar	
6000	410339	Relais für RMP210	Relays for RMP210	
6000	K2590-16			
6000	MP671140			
6000	MP671140a			

## Guarantee

All machines perform a functional and continuous operation test before delivery. On the machine, we grant our customers a bring-in-warranty of 12 months from the date of purchase with regard to accuracy in material and workmanship. We provide a warranty of our choice by replacing defective parts or by repairing the machine in our house. Old parts become our property.

## Disclaimer of Warranty

Bungard GmbH & Co. KG reserves the right to make any changes or improvements to any machine or machine specification it deems necessary at its sole discretion, and assumes no obligation to implement such changes in previously sold machines.

Bungard products and services are subject to the then prevailing prices and terms. These prices and conditions are subject to change.

The information in this document is subject to change and does not constitute any representation on the part of Bungard.

This manual contains information for the RMP210 and the RMP3545 and is the translation of the original instructions.

Conditions of sale and delivery: These are available to the buyer at the latest when the contract is fulfilled. We do not warrant or accept any liability for damage to material or personal injury caused by any of the following:

Improper use of the machine

Incorrect setup, commissioning and operation of the machine or inadequate service

Use of the machine with damaged safety devices

Non-compliance with the manual regarding transport, storage, assembly, installation and service of the machine

Unauthorized changes to the machine

Improper or incomplete repairs

Destructive forces on the machine due to foreign bodies or strong external use of force

Use of non-original spare parts

Wear parts are excluded from warranty.

We can not accept any replacement or follow-up claims arising from damage or destruction of workpieces machined in the machine, since the parameters influencing the operation of the machine are largely beyond our control.

This applies mutatis mutandis to claims arising from damage to objects, buildings and people and the environment.

All information has been compiled with care. We reserve the right, however to errors and technical changes, even without notice,

Operation in an aggressive, dusty, damp, extremely hot or potentially explosive environment is at the user's own risk and responsibility.

The user must take care of appropriate precautions and protective equipment. Any liability for damage caused by operation in such an environment is hereby expressly excluded.

## Copyright

© 2018 Bungard Elektronik GmbH & Co. KG

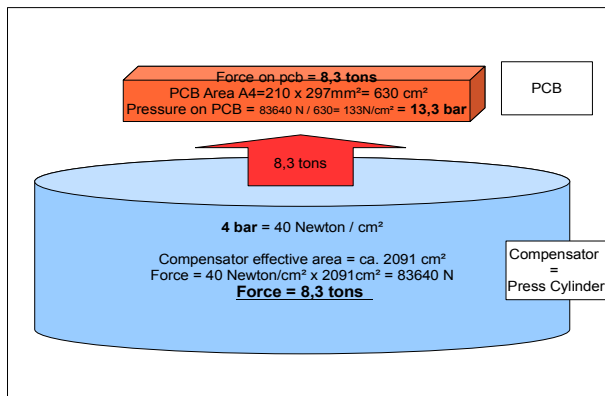

**Pressing Preferences**

Pressure	1 bar	=	10 N/cm²				
Compressor pressure in bar	Gravitational force on Compensator area RMP 3545: effective area 2091cm²			Pressure in bar at 875 cm² (Press plates RMP210 250x350mm)	Pressure in bar at 160 cm² (Eurocard 100x160mm)	Pressure in bar at 1575 cm² (Press plates RMP 3545 450x350mm)	Pressure in bar at 630 cm² (Din A 4 210 x 297)
	in Newton	In Kilo	In Tonnen				
1	20910	2091,0	2,091	2,4	13,1	1,3	3,3
2	41820	4182,0	4,182	4,8	26,1	2,7	6,6
3	62730	6273,0	6,273	7,2	39,2	4,0	10,0
4	83640	8364,0	8,364	9,6	52,3	5,3	13,3
5	104550	10455,0	10,455	11,9	65,3	6,6	16,6
6	125460	12546,0	12,546	14,3	78,4	8,0	19,9
7	146370	14637,0	14,637	16,7	91,5	9,3	23,2
8	167280	16728,0	16,728	19,1	104,6	10,6	26,6
9	188190	18819,0	18,819	21,5	117,6	11,9	29,9
10	209100	20910,0	20,910	23,9	130,7	13,3	33,2
11	230010	23001,0	23,001	26,3	143,8	14,6	36,5
12	250920	25092,0	25,092	28,7	156,8	15,9	39,8
13	271830	27183,0	27,183	31,1	169,9	17,3	43,1
14	292740	29274,0	29,274	33,5	183,0	18,6	46,5

RMP210 normal	Compensator with nominal width 300mm has effective area of 830 cm²					
Compressor pressure in bar	Gravitational force on Compensator area RMP 210: effective area 830 cm²			Pressure in bar at 875 cm² (Press plates RMP210 250x350mm)	Pressure in bar at 160 cm² (Eurocard 100x160mm)	Pressure in bar at 630 cm² (Din A 4 210 x 297)
	in Newton	In Kilo	In Tonnen			
1	8300	830,0	0,830	0,9	5,2	1,3
2	16600	1660,0	1,660	1,9	10,4	2,6
3	24900	2490,0	2,490	2,8	15,6	4,0
4	33200	3320,0	3,320	3,8	20,8	5,3
5	41500	4150,0	4,150	4,7	25,9	6,6
6	49800	4980,0	4,980	5,7	31,1	7,9
7	58100	5810,0	5,810	6,6	36,3	9,2
8	66400	6640,0	6,640	7,6	41,5	10,5
9	74700	7470,0	7,470	8,5	46,7	11,9
10	83000	8300,0	8,300	9,5	51,9	13,2
11	91300	9130,0	9,130	10,4	57,1	14,5
12	99600	9960,0	9,960	11,4	62,3	15,8
13	107900	10790,0	10,790	12,3	67,4	17,1